

MM-187/32 model

Characteristic

Wire resistor type MM-187/32 is composed of three serial connected resistors. These type of resistors are used in car blower unit for step by step control of fan motor speed. All MM-187/32 have a thermal fuse which disconnects blower circuit in emergency situations, after exceeding the specified safety temperature.

Parameter	Value
Operating voltage	12 V
Resistance tolerance	±10 %

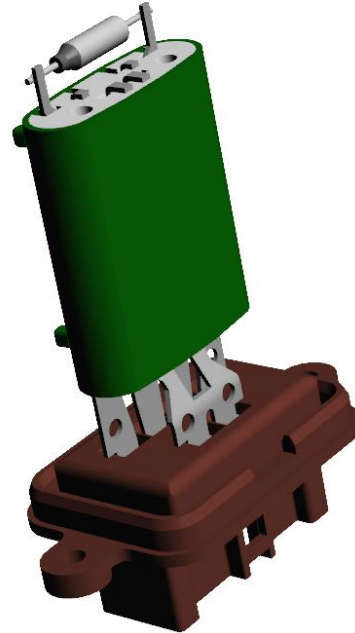

Schematic diagram

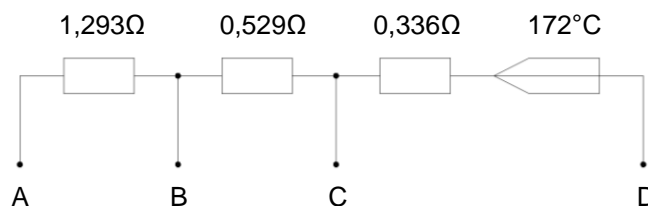

Dimensions

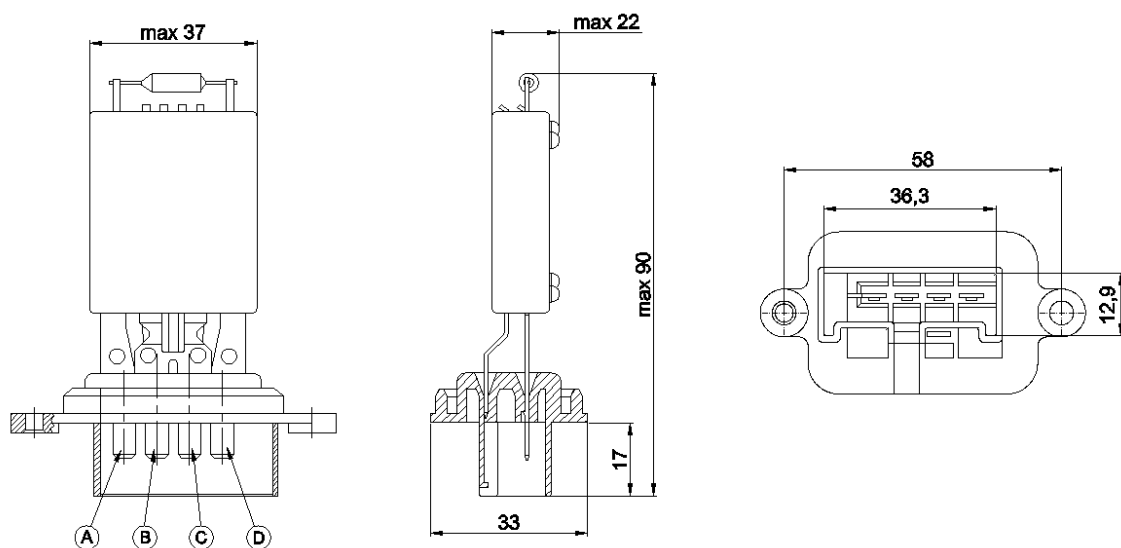

TELPOD S.A.

str. Pilsudskiego 63A
32-050 Skawina
www.telpod.pl

Technical division: +48 (0)12 257 10 12
Sales division: +48 (0)12 257 10 35
fax: +48 (0)12 257 10 13
e-mail: telpod@telpod.pl

date: 04 / 2015
Copyright 2015 by Telpod